

TotalGrow™ Stratum

Indoor Farming Lighting
Refined, Powerful, Efficient

- Exceptionally thin profile to maximize space
- Full spectrum and modular design for exceptional versatility
- Broad panel/bar hybrid for improved uniformity and penetration
- Simple mounting and electrical installation to save time and costs

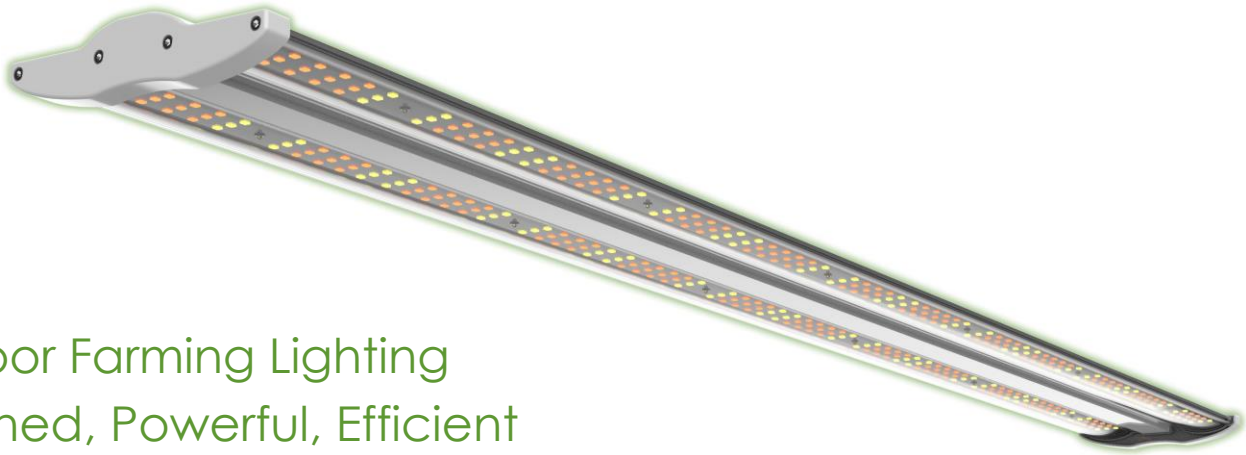
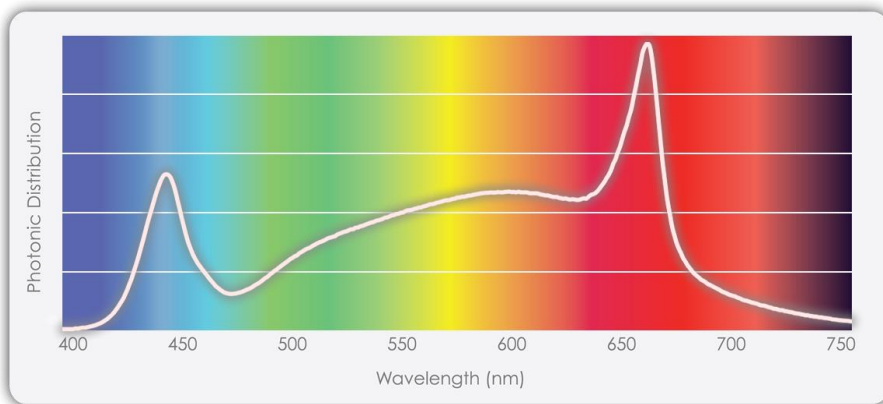

Spectrum Customization Available

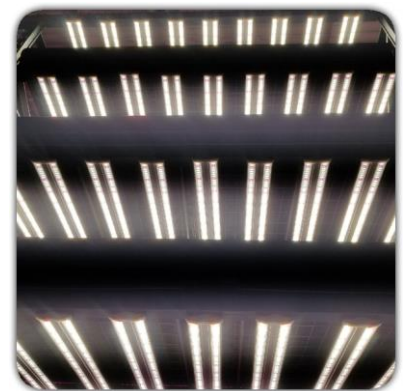

The TotalGrow Stratum is designed and refined to maximize yields, space and versatility while minimizing costs. The spectrum and size are ideal for low/no-sunlight growing in virtually any vertical farm, growth chamber, propagation system, tower garden and more. Exceptional efficiencies and light delivery potential, along with long, low maintenance lifespans provide long-term sustainability.

Product Specifications / Installation

Specification	TG4B	TG6B
Power Consumption	40W	60W
Output	95 $\mu\text{mol/s}$	135 $\mu\text{mol/s}$
Output Efficiency	2.4 $\mu\text{mole/J}$	2.3 $\mu\text{mole/J}$
Typical Coverage Example	12"x48" (225 PPFD) 5-12" over canopy	15"x48" (250 PPFD) 8-15" over canopy
Dimensions (LxWxH)	44"x5.1"x1.2" (35" and 47" lengths available)	
Input Voltage	100-277VAC, 50/60 Hz	
Projected Service Life	50,000 hours	
Warranty	5 Years	
Waterproof	IP65	
Contact: info@venntis.com		

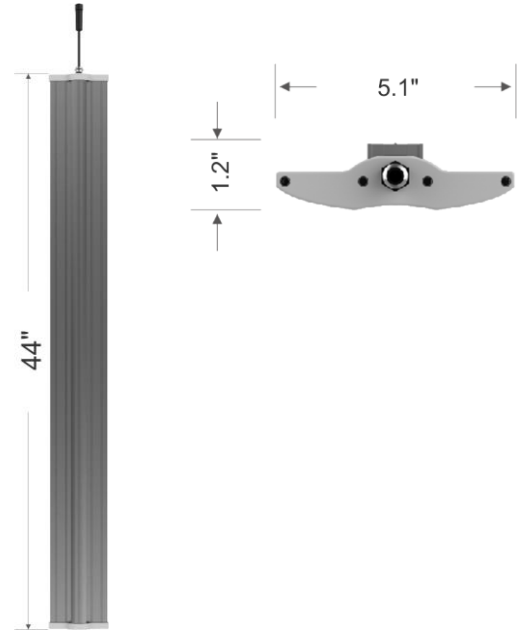

Usage Guidelines

Every application is unique, and our lighting experts will gladly provide you with a detailed, custom light plan (contact info@venntis.com).

Custom wiring harnesses create the cleanest, simplest power distribution for your operation. An example is shown for a typical $250 \mu\text{mol}\cdot\text{m}^{-2}\cdot\text{s}^{-1}$ setup over several 4'x8' shelves.

Minimum height requirements are as low as 3-4" total above the plants, though higher heights can be used as well.

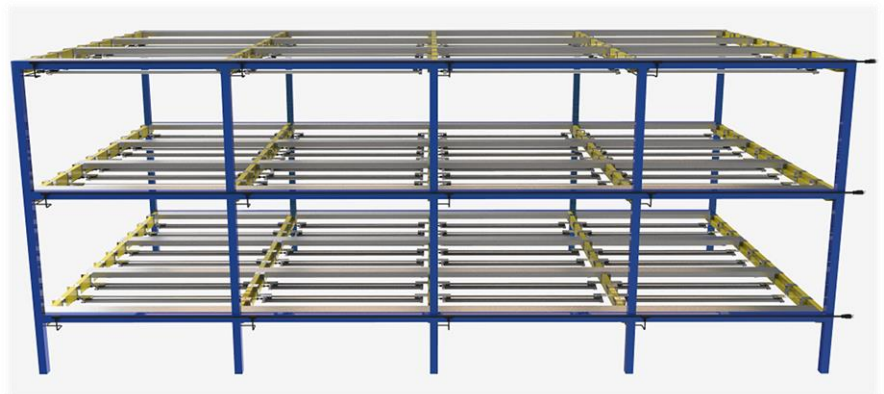
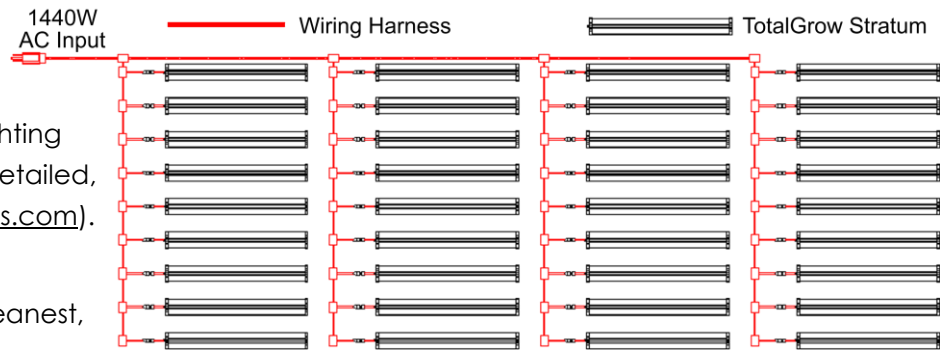

Maximize yields, quality, plant density, space and uniformity.
Minimize costs, power consumption, maintenance, effort and headaches.